

EMCO SPECIALTY PRODUCTS, INC.

408 MIAMI AVE. KANSAS CITY, KS 66105 - 913-281-4555 / FAX. 913-281-4554

13P2 HOOK PANEL

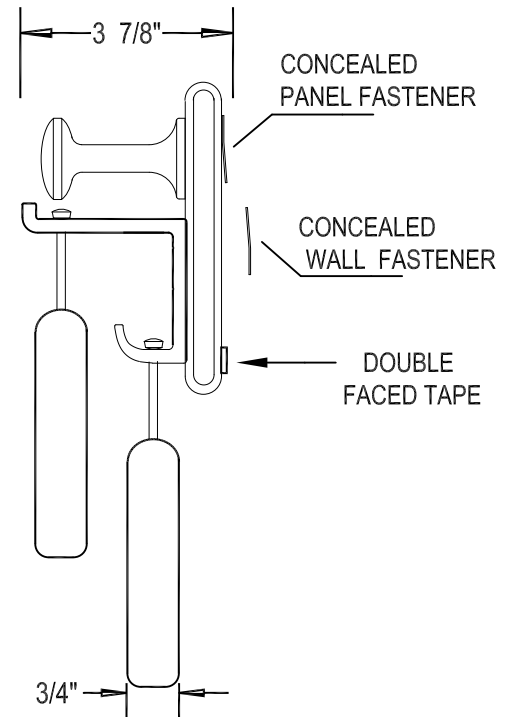
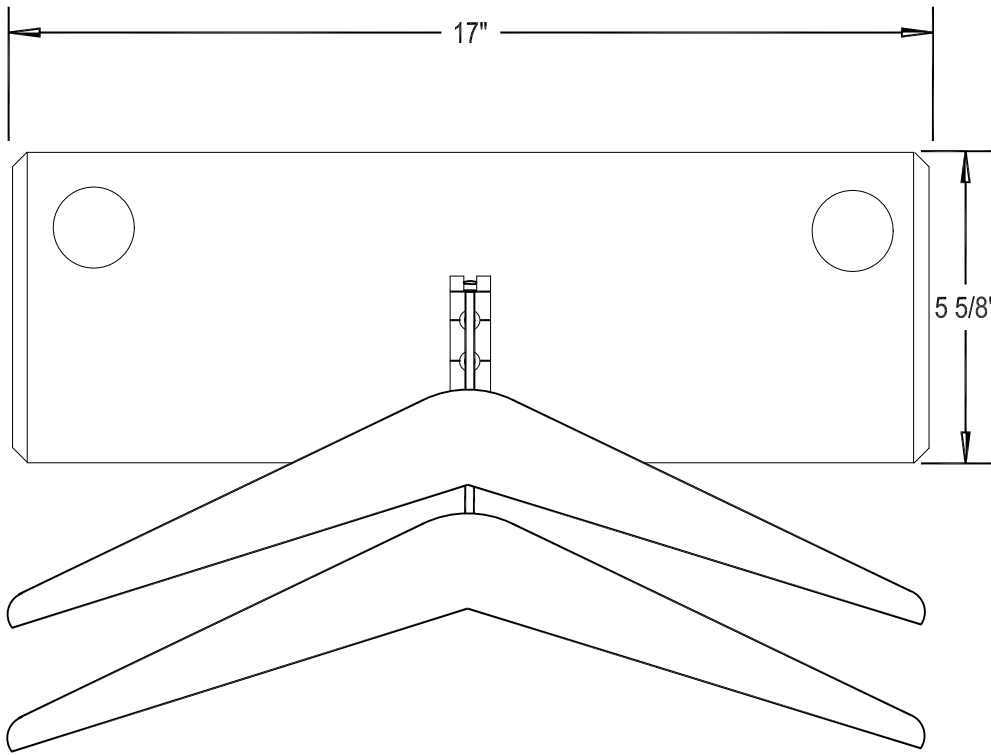

WALL FASTENERS BY OTHERS

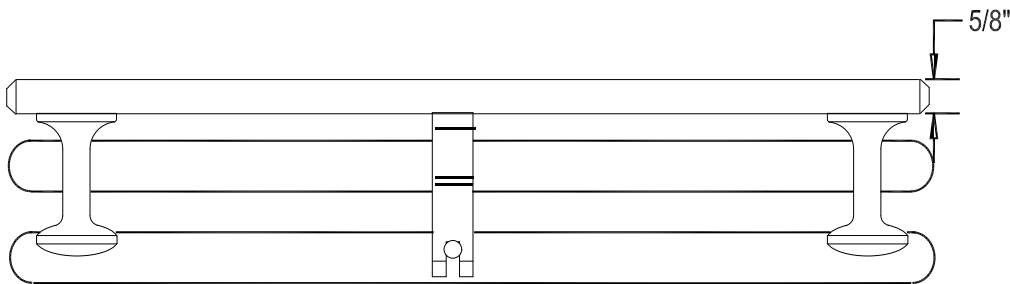

HOOKS : SOLID ALUMINUM
 A. SILVER
 B. BLACK

SOLID WOOD PANEL FINISHES:
 A. LIGHT OAK
 B. MEDIUM OAK
 C. WALNUT
 D. UNFINISHED OAK

PLEASE SPECIFY:

QUANTITY REQUIRED: _____

PANEL FINISH _____

HOOK FINISH _____

PROJECT: _____

LOCATION: _____

DISTRIBUTOR: _____

DRAWING NO. : _____ DATE: _____

SHEET: _____ OF _____ REVISIONS: _____